

**org**EO SLAB

**org**  
cerámica

## geoSLAB

The ceramic industry evolves at a global level, and Geotiles continues maintaining a solid bet for the innovation and development of new designs and finishes.

The collection of designs **GeoSLAB** comprehends porcelain slabs of a voluminous formats, 120x280cm with 6mm thickness and 160x160 with 8mm thickness, ideal for resistant surfaces, hygienic and easy cleanliness and high-ending maintenance.

Geotiles is pleased to offer to its clients a huge aesthetic potential able to take the essence of every and each project, from applications to walls and floors including furniture (kitchen or bathroom countertops, washbasins, tables, etc.) and commercial and residential application either for interiors or exteriors spaces.

---

El sector cerámico evoluciona a nivel mundial, y desde Geotiles continuamos manteniendo una firme apuesta por la innovación y el desarrollo de nuevos diseños y acabados.

La colección de diseños **GeoSLAB** son placas de gres porcelánico de gran formato, 120x280cm con espesor 6mm y 160x160 con espesor 8mm, ideales para superficies resistentes, higiénicas, de fácil limpieza y mantenimiento altamente resistente.

Con estos gran formatos desde Geotiles queremos ofrecer a nuestros clientes un potencial estético capaz de interpretar la esencia de cada proyecto; desde revestimiento de paredes y pavimentos, hasta elementos mobiliarios (encimeras de cocina o baño, lavabos, mesas, etc...), para ambientes comerciales y residenciales con aplicaciones tanto en interiores como exteriores.

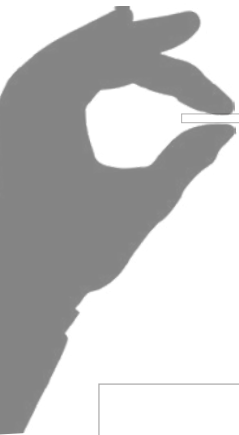

6MM

8MM



ALABASTRINO



ARTEMISA



ARPEGGIO

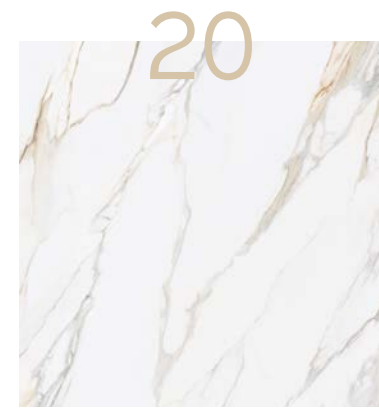

AURORA

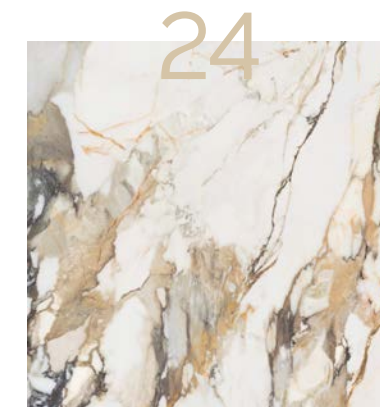

CRASH

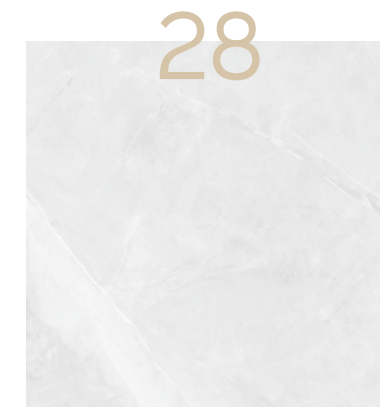

MAGDA



ONI



SAHARA



EDDYSTONE

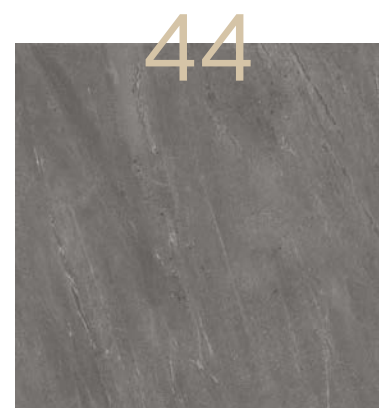

LAVICA

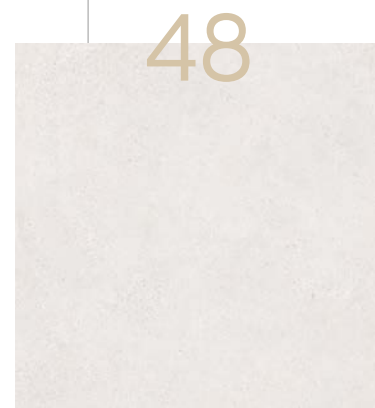

MEMORY



CARNABY



GROUND



PORTLAND



BLANCO

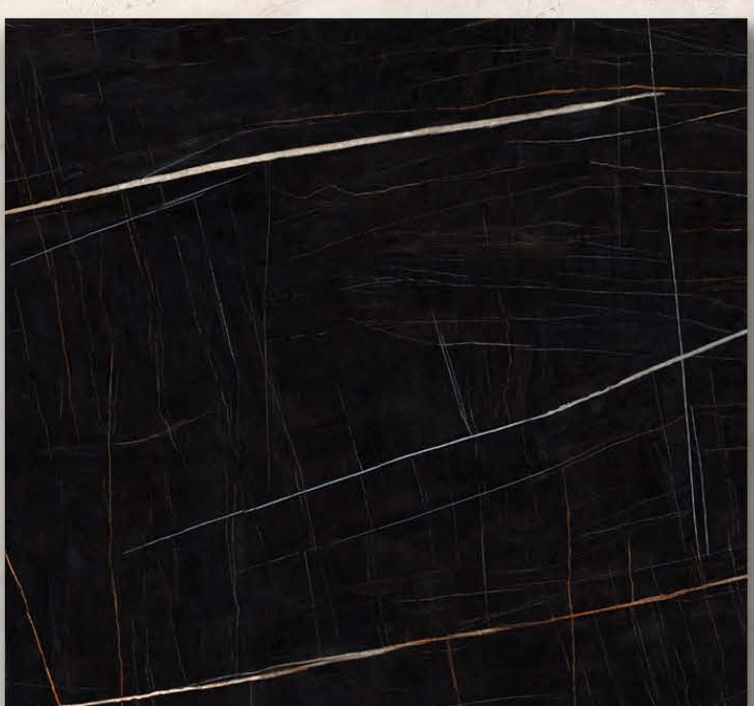

**THICKNESS & SIZES**  
ESPESOR Y FORMATOS



The 6mm 120x280 and the 8mm 160x160 formats keeps the excellent aesthetic and mechanical features, allowing to cover spaces from ground to roof using only one piece, offering wide possibilities and quality for architects and designers projects.

Los formatos de estas piezas 120x280mm (con espesor fino de 6mm) y 160x160cm (con espesor de 8mm), mantienen excelentes propiedades estéticas y mecánicas. Permiten recubrir espacios de suelo a techo con una solo pieza, ofreciendo grandes posibilidades y calidad para los proyectos de interioristas y arquitectos.

**160x160 63"x63"**  
**8MM**

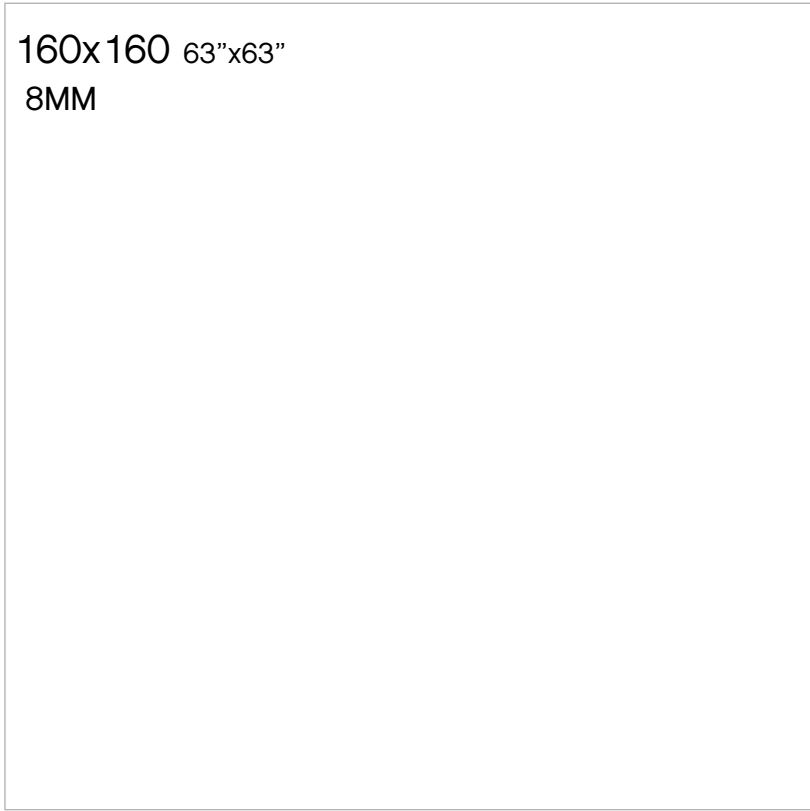









**120x280 48"x110"**  
**6MM**



# GEO SLAB

-  **Lightweight**  
Ligereza
-  **Modulus of rupture**  
Resistencia a la flexión
-  **Chemical resistance**  
Resistencia química
-  **Frost resistance**  
Resistencia a la helada
-  **Thermal shock resistance**  
Resistencia al choque térmico
-  **Water absorption**  
Absorción de agua
-  **Resistance to stains**  
Resistencia a las manchas
-  **Resistance to superficial abrasion**  
Resistencia a la abrasión superficial
-  **Wear resistant**  
Resistencia al desgaste
-  **Scratch resistance**  
Resistencia al rayado
-  **Easy maintenance**  
Fácil mantenimiento
-  **Hygienic and anti-allergenic**  
Higiénico y antialérgico
-  **Fireproof**  
Ignífugo
-  **Ecologic**  
Ecológico

**LEGEND /**  
SIMBOLOGÍA

-  **Wall Tiles**  
Revestimiento
-  **Floor Tiles**  
Pavimento
-  **High Polished**  
Alto Pulido
-  **Satin matt**  
Satinado mate
-  **Matt**  
Mate
-  **High shade variation**  
Destonificado
-  **Thickness**  
Espesor
-  **Thickness**  
Espesor

# ALABASTRINO

PORCELAIN · PORCELÁNICO

geoSLAB

The Alabastrino series is an ivory cream porcelain tile that combines the elegance of classic marbles with the serenity of ivory cream. Its surface reflects the grandeur of the past while its strength ensures durability. Each tile is a fragment of a timeless story where beauty endures and history reinvents itself.

La serie Alabastrino es un porcelánico crema marfil que combina la elegancia de los mármoles clásicos con la serenidad del crema marfil. Su superficie refleja la grandeza del pasado mientras que su resistencia asegura durabilidad. Cada baldosa es un fragmento de una historia atemporal donde la belleza perdura y la historia se reinventa.



Alabastrino Marfil 160x160/ 63"x63"

# ALABASTRINO

PORCELAIN · PORCELÁNICO

BLANCO



AVAILABLE COLOURS · COLORES DISPONIBLES



BLANCO



MARFIL

FORMATOS DISPONIBLES · AVAILABLE SIZES

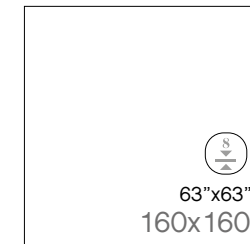

CARACTERÍSTICAS TÉCNICAS · TECHNICAL CHARACTERISTICS



Wall Tiles  
Revestimiento



Floor Tiles  
Pavimento



High Polished  
Alto Pulido



Satin matt  
Satinado mate



High shade variation  
Destonificado



Thickness  
Espesor



Thickness  
Espesor

PACKING LIST

Size Medida	Pcs/Pallet Pz/Palet	Sqm/Box m <sup>2</sup> /Caja	Sqm/Pallet m <sup>2</sup> /Palet	Kg/Pallet Kg/Palet
120x280	20	3,36	67,20	1.062,00
160x160	20	2,56	51,20	1.066,00

	120x280	160x160
● Satinado	M171	M205
✦ Pulido	M172	M206

# ARTEMISA

PORCELAIN · PORCELÁNICO

geoSLAB

Artemisa, for its exclusive design and elegant appearance, fits perfectly with the most minimalist interior design without giving up the classic.  
A collection that brings brightness, elegance and distinction to the spaces.

Artemisa por su diseño exclusivo y su apariencia elegante, encaja a la perfección con el interiorismo más minimalista sin renunciar al clásico.  
Una colección que aporta a los espacios luminosidad, elegancia y distinción.



Artemisa Blanco 120x280 / 48"x110"



# ARTEMISA

PORCELAIN · PORCELÁNICO

BLANCO



AVAILABLE COLOURS · COLORES DISPONIBLES



BLANCO

FORMATOS DISPONIBLES · AVAILABLE SIZES

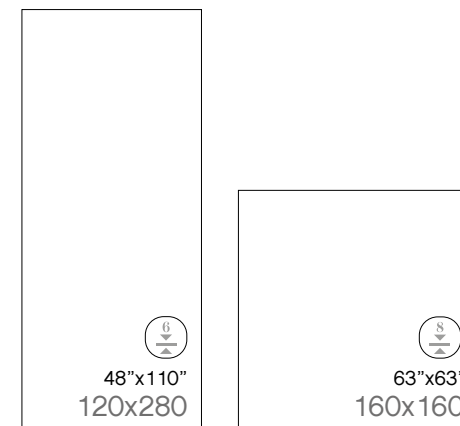

CARACTERÍSTICAS TÉCNICAS · TECHNICAL CHARACTERISTICS



Wall Tiles  
Revestimiento



Floor Tiles  
Pavimento



High Polished  
Alto Pulido



Satin matt  
Satinado mate



High shade variation  
Destonificado



Thickness  
Espesor



Thickness  
Espesor

PACKING LIST

Size Medida	Pcs/Pallet Pz/Palet	Sqm/Box m <sup>2</sup> /Caja	Sqm/Pallet m <sup>2</sup> /Palet	Kg/Pallet Kg/Palet
120x280	20	3,36	67,20	1.062,00
160x160	20	2,56	51,20	1.066,00

	120x280	160x160
● Satinado	M171	M205
✦ Pulido	M172	M206

# ARPEGGIO

PORCELAIN · PORCELÁNICO

geoSLAB

Inspired by the limestone of very thin and uniform grains with a magnificent grey color with slim white veins. Arpeggio is a perfect marble to highlight the beauty and elegance of spaces where to offer personality, modernity and contemporaneity.

Inspirado en una caliza compacta de grano muy fino y uniforme de un espléndido color gris con finas vetas blancas. Arpeggio es un mármol perfecto para realzar la belleza y elegancia de diferentes espacios ya que ofrece carácter, personalidad, modernidad y contemporaneidad.



Arpeggio Nero 120x280 / 48"x110"

# ARPEGGIO

PORCELAIN · PORCELÁNICO

NERO

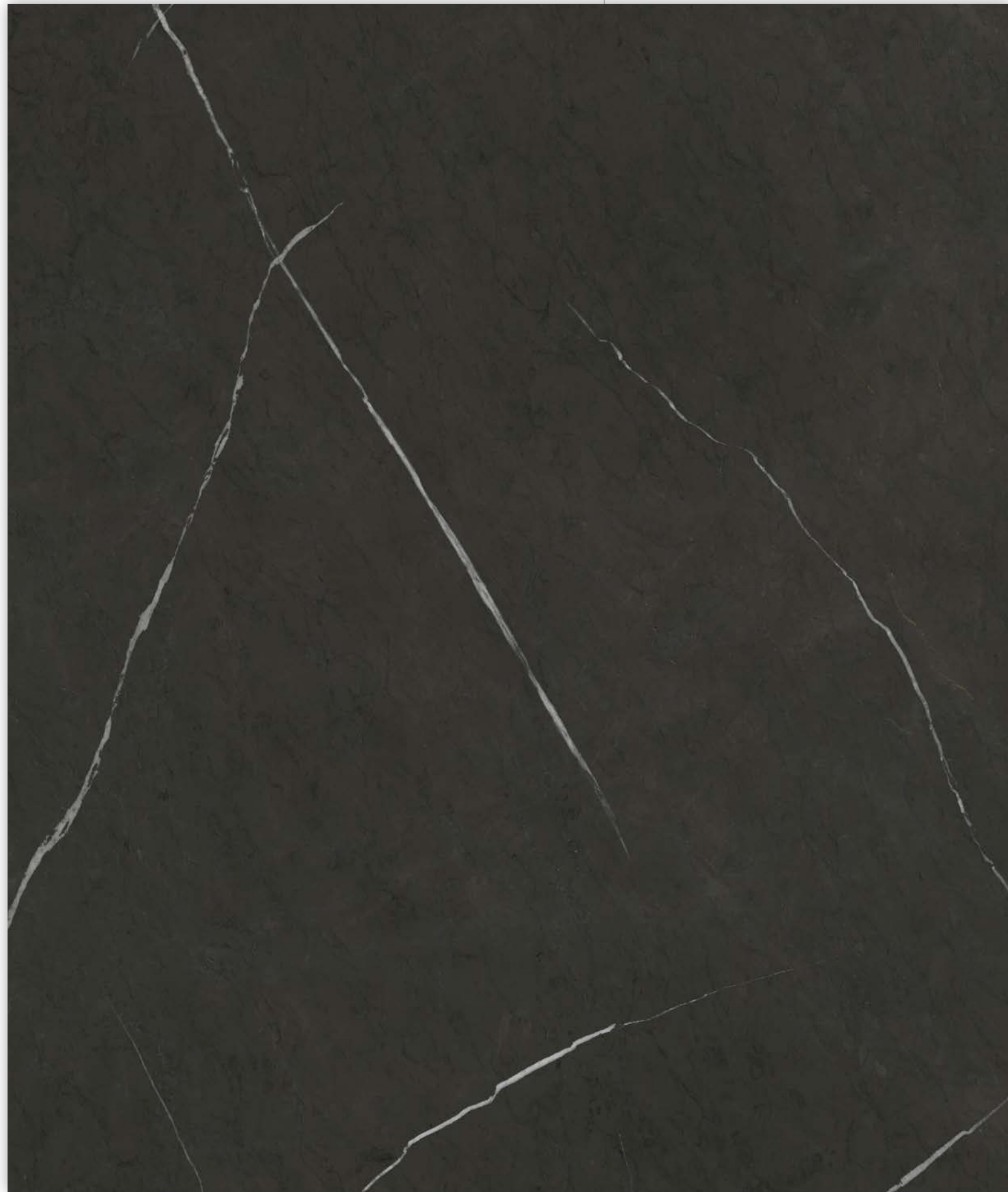

AVAILABLE COLOURS · COLORES DISPONIBLES



NERO

FORMATOS DISPONIBLES · AVAILABLE SIZES

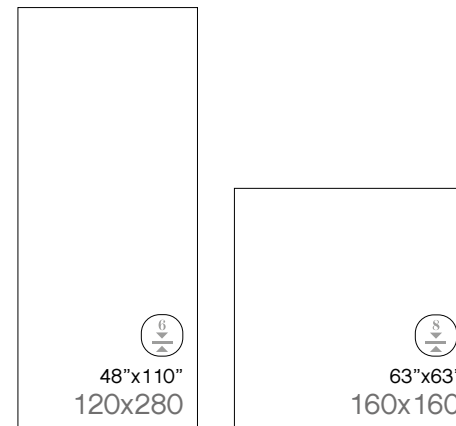

CARACTERÍSTICAS TÉCNICAS · TECHNICAL CHARACTERISTICS



Wall Tiles  
Revestimiento



Floor Tiles  
Pavimento



Matt  
Mate



High shade variation  
Destonificado



Thickness  
Espesor



Thickness  
Espesor

PACKING LIST

Size Medida	Pcs/Pallet Pz/Palet	Sqm/Box m <sup>2</sup> /Caja	Sqm/Pallet m <sup>2</sup> /Palet	Kg/Pallet Kg/Palet
120x280	20	3,36	67,20	1.062,00
160x160	20	2,56	51,20	1.066,00

	120x280	160x160
● Mate	M171	M205

# AURORA

PORCELAIN · PORCELÁNICO

geoSLAB

A series simulating the calacatta marble that combines two tonalities as if it was a brush-stroke. The gentle gold and smoke lines flow through the white background bringing personality and distinction in equal measurement. One of the aims of these series is to exalt the natural patterns of this marble original from the Alpes Apuanos of the Toscana and manage to recreate the nuances and veining that for millenia have enriched the houses and palaces throughout periods and styles. A marble for every kind of space, providing elegance, sophistication and luxury.

Serie imitación mármol calacatta que combina dos tonalidades como si de unas pinceladas se tratara. Las suaves líneas oro y humo riegan el fondo blanco aportando personalidad y distinción a partes iguales. Uno de los objetivos de esta serie es realzar los patrones naturales de este mármol originario de los Alpes Apuanos en la Toscana y conseguir recrear los matices y vetas que durante milenios han enriquecido casas y palacios de todas las épocas y estilos.

Un mármol para todo tipo de espacios, aportando siempre elegancia, sofisticación y lujo.



Aurora Gold 120x280 / 48"x110"

# AURORA

PORCELAIN · PORCELÁNICO

GOLD



AVAILABLE COLOURS · COLORES DISPONIBLES



GOLD

FORMATOS DISPONIBLES · AVAILABLE SIZES

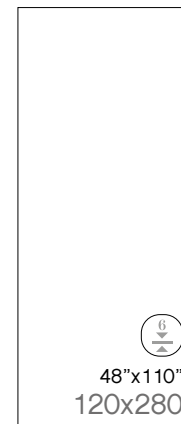

48"x110"  
120x280

CARACTERÍSTICAS TÉCNICAS · TECHNICAL CHARACTERISTICS



Wall Tiles  
Revestimiento



Floor Tiles  
Pavimento



High Polished  
Alto Pulido



Satin matt  
Satinado mate



High shade variation  
Destonificado



Thickness  
Espesor

PACKING LIST

Size Medida	Pcs/Pallet Pz/Palet	Sqm/Box m <sup>2</sup> /Caja	Sqm/Pallet m <sup>2</sup> /Palet	Kg/Pallet Kg/Palet
120x280	20	3,36	67,20	1.062,00

	120x280
<input checked="" type="radio"/> Mate	M171

# CRASH

PORCELAIN · PORCELÁNICO

geoSLAB

The Crash collection, inspired by prestigious marbles. With its polished finish and the expressive power of natural marble, it becomes a designer material to personalize every space. A collection defined by a great technical care that makes the atmospheres shine with their own light.

La colección Crash, inspirada en los mármoles prestigiosos. Con su acabado pulido y el poder expresivo del mármol natural, se convierte en material de diseño para personalizar cada espacio. Una colección definida por un gran cuidado técnico que hace que los ambientes brillen con luz propia.



Crash Blanco 120x280 / 48"x110"

# CRASH

PORCELAIN · PORCELÁNICO

BEIGE



## AVAILABLE COLOURS · COLORES DISPONIBLES

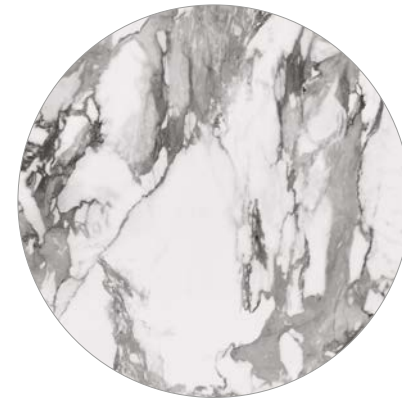

BLANCO



BEIGE

## FORMATOS DISPONIBLES · AVAILABLE SIZES



## CARACTERÍSTICAS TÉCNICAS · TECHNICAL CHARACTERISTICS



Wall Tiles  
Revestimiento



Floor Tiles  
Pavimento



High Polished  
Alto Pulido



Satin matt  
Satinado mate



High shade variation  
Destonificado



Thickness  
Espesor

## PACKING LIST

Size Medida	Pcs/Pallet Pz/Palet	Sqm/Box m <sup>2</sup> /Caja	Sqm/Pallet m <sup>2</sup> /Palet	Kg/Pallet Kg/Palet
120x280	20	3,36	67,20	1.062,00

	120x280
Satinado	M171
Pulido	M172

# MAGDA

PORCELAIN · PORCELÁNICO

geoSLAB

Magda is a marble reinventing the classic pulpis, inspired by the native material from Santa Magdalena de Pulpis, a town located in Castellon province.

This collection maintains a homogenous tone combined with the classic natural lines that features this type of stone with whitish veins providing elegance and personality to every space.

Inspirado en el material originario del pueblo de la provincia de Castellón, Santa Magdalena de Pulpis. Magda es un mármol que reinventa el clásico Pulpis.

Esta colección mantiene un tono base homogéneo combinando con las clásicas líneas naturales que caracterizan a este tipo de piedra, unas vetas blanquecinas que aportan elegancia y personalidad en cada imagen.



Magda Marfil 120x280 / 48"x110"  
Magda Marfil 160x160 / 63"x63"



# MAGDA

PORCELAIN · PORCELÁNICO

PERLA



## AVAILABLE COLOURS · COLORES DISPONIBLES



BLANCO



PERLA

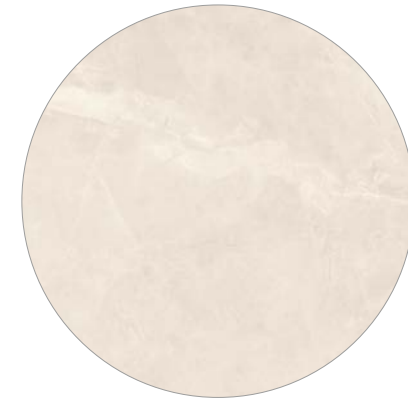

MARFIL

## FORMATOS DISPONIBLES · AVAILABLE SIZES

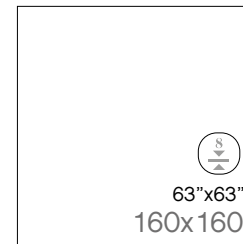

## CARACTERÍSTICAS TÉCNICAS · TECHNICAL CHARACTERISTICS



Wall Tiles  
Revestimiento



Floor Tiles  
Pavimento



High Polished  
Alto Pulido



Satin matt  
Satinado mate



High shade variation  
Destonificado



Thickness  
Espesor



Thickness  
Espesor

## PACKING LIST

Size Medida	Pcs/Pallet Pz/Palet	Sqm/Box m <sup>2</sup> /Caja	Sqm/Pallet m <sup>2</sup> /Palet	Kg/Pallet Kg/Palet
120x280	20	3,36	67,20	1.062,00
160x160	20	2,56	51,20	1.066,00

	120x280	160x160
● Satinado	M171	M205
✦ Pulido	M172	M206

# ONI

PORCELAIN · PORCELÁNICO

geoSLAB

With Oni we reinvent the classic onyx marble, a semi-precious stone, elegant and timeless.

Its high bright finish contribute to sophisticated and unique space.

Con la serie Oni reinventamos el clásico mármol ónice, una piedra semi-preciosa, elegante y atemporal. Su acabado alto brillo aporta a cada estancia un aspecto sofisticado y único.



Oni White 120x280 / 48"x110"

PORCELAIN · PORCELÁNICO

WHITE

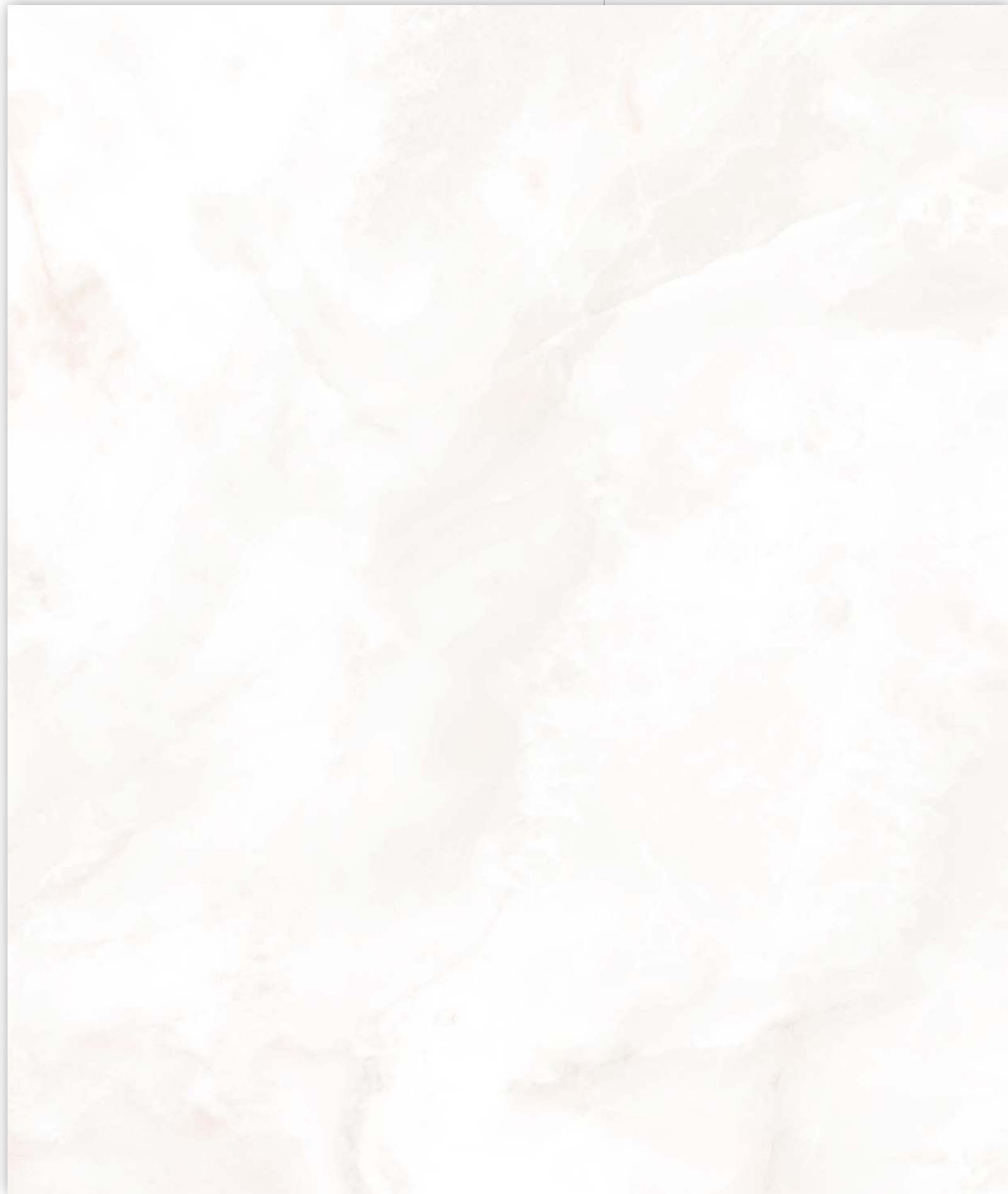

AVAILABLE COLOURS · COLORES DISPONIBLES

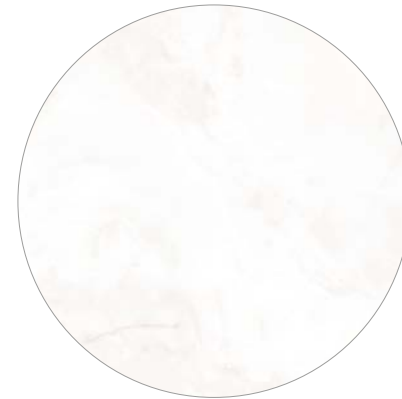

WHITE

FORMATOS DISPONIBLES · AVAILABLE SIZES



CARACTERÍSTICAS TÉCNICAS · TECHNICAL CHARACTERISTICS



Wall Tiles  
Revestimiento



Floor Tiles  
Pavimento



High Polished  
Alto Pulido



Satin matt  
Satinado mate



High shade variation  
Destonificado



Thickness  
Espesor

PACKING LIST

Size Medida	Pcs/Pallet Pz/Palet	Sqm/Box m <sup>2</sup> /Caja	Sqm/Pallet m <sup>2</sup> /Palet	Kg/Pallet Kg/Palet
120x280	20	3,36	67,20	1.062,00

	120x280
Satinado	M171
Pulido	M172

# SAHARA

PORCELAIN · PORCELÁNICO

geoSLAB

Thanks to its weave, the Sahara series has an overwhelming personality and brings depth and a wealth of elegance, a timeless treasure that lasts forever.

Sahara, with its super polished finish, is luxury and seduction, capable of adding a touch of charm to the most diverse architectural projects, from traditional contexts to more minimalist situations.

---

Gracias su entramado la serie Sahara presenta una personalidad arrolladora y aporta profundidad y una riqueza de elegancia, un tesoro intemporal que dura para siempre.

Sahara, con acabado super pulido, es lujo y seducción, capaz de añadir un toque de encanto a los más diversos proyectos arquitectónicos, desde contextos tradicionales a situaciones más minimalistas.



Sahara Noir 120x280 / 48"x110"

# SAHARA

PORCELAIN · PORCELÁNICO

NOIR

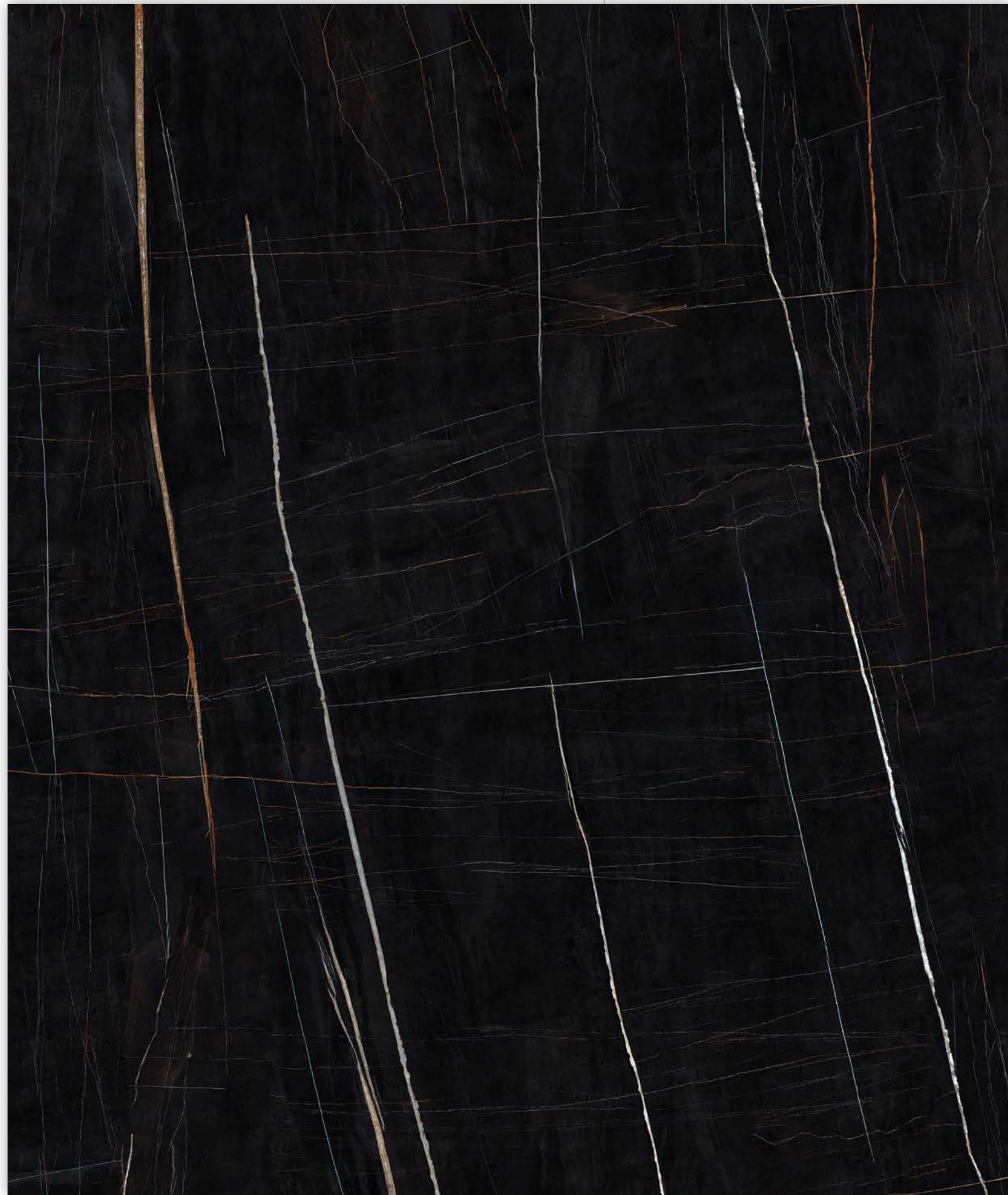

AVAILABLE COLOURS · COLORES DISPONIBLES



NOIR

FORMATOS DISPONIBLES · AVAILABLE SIZES

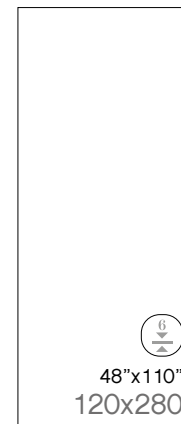

48"x110"  
120x280

CARACTERÍSTICAS TÉCNICAS · TECHNICAL CHARACTERISTICS



Wall Tiles  
Revestimiento



Floor Tiles  
Pavimento



High Polished  
Alto Pulido



Satin matt  
Satinado mate



High shade variation  
Destonificado



Thickness  
Espesor

PACKING LIST

Size Medida	Pcs/Pallet Pz/Palet	Sqm/Box m <sup>2</sup> /Caja	Sqm/Pallet m <sup>2</sup> /Palet	Kg/Pallet Kg/Palet
120x280	20	3,36	67,20	1.062,00

	120x280
Satinado	M171
Pulido	M172

# EDDYSTONE

PORCELAIN · PORCELÁNICO

geoSLAB

This series pays homage to the rich heritage of Burlington's quarries. Designed with precision and advanced technology, it captures the authenticity of natural stone in every detail. Inspired by the tones of the quarry, its versatile color palette adapts to a variety of styles. The durability of ceramic combines with the sophisticated aesthetics of Burlington stone, offering a durable and elegant solution for wall and floor coverings.

Esta serie rinde homenaje a la rica herencia de las canteras de Burlington. Diseñada con precisión y tecnología avanzada, captura la autenticidad de la piedra natural en cada detalle. Inspirada en los tonos de la cantera, su paleta de colores versátil se adapta a diversos estilos.

La durabilidad de la cerámica se combina con la estética sofisticada de la piedra Burlington, ofreciendo una solución resistente y elegante para revestir paredes y suelos.



Eddystone Perla 120x280 / 48"x110"  
Eddystone Blanco 120x280 / 48"x110"

# EDDYSTONE

PORCELAIN · PORCELÁNICO

ARENA



## AVAILABLE COLOURS · COLORES DISPONIBLES



BLANCO



PERLA



ARENA

## FORMATOS DISPONIBLES · AVAILABLE SIZES

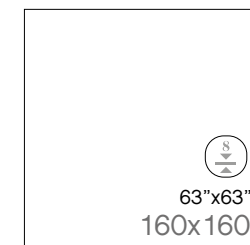

## CARACTERÍSTICAS TÉCNICAS · TECHNICAL CHARACTERISTICS



Wall Tiles  
Revestimiento



Floor Tiles  
Pavimento



Matt  
Mate



High shade variation  
Destonificado



Thickness  
Espesor



Thickness  
Espesor

## PACKING LIST

Size Medida	Pcs/Pallet Pz/Palet	Sqm/Box m <sup>2</sup> /Caja	Sqm/Pallet m <sup>2</sup> /Palet	Kg/Pallet Kg/Palet
120x280	20	3,36	67,20	1.062,00
160x160	20	2,56	51,20	1.066,00

	120x280	160x160
● Mate	M171	M205

# LAVICA

PORCELAIN · PORCELÁNICO

geoS<sub>L</sub>AB

A collection inspired in the volcanic original stone. A contemporary porcelain with stony look showing its strength characterized by its versatile.  
A collection developed in several shades that bring us to the original nature materials (pearl and mica).

Serie inspirada en la piedra de origen volcánico. Este porcelánico contemporáneo de aspecto pétreo con mucha fuerza destaca por su gran versatilidad.  
Serie desarrollada en varios tonos que recuerdan a la naturaleza del material original (perla y mica).



Lavica Perla 120x280 / 48"x110"



PORCELAIN · PORCELÁNICO

GRIS



AVAILABLE COLOURS · COLORES DISPONIBLES



BLANCO



PERLA

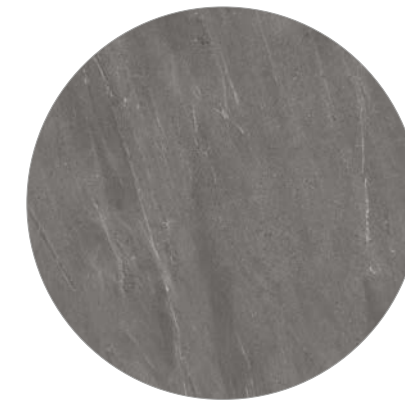

GRIS



MICA

FORMATOS DISPONIBLES · AVAILABLE SIZES



CARACTERÍSTICAS TÉCNICAS · TECHNICAL CHARACTERISTICS



Wall Tiles  
Revestimiento



Floor Tiles  
Pavimento



Matt  
Mate



High shade variation  
Destonificado



Thickness  
Espesor

PACKING LIST

Size Medida	Pcs/Pallet Pz/Palet	Sqm/Box m <sup>2</sup> /Caja	Sqm/Pallet m <sup>2</sup> /Palet	Kg/Pallet Kg/Palet
120x280	20	3,36	67,20	1.062,00

	120x280
● Mate	M171

# MEMORY

PORCELAIN · PORCELÁNICO

geoSLAB

The collection reinterprets the elegance of the stone providing life to spaces with a strong eloquence. The richness of the surface details reproduces a highly realistic stone effect creating environments of a great aesthetic value. With a range of natural and soft colors, it is ideal to create continuity through the spaces, makes the collection suitable for to elegant and refined scenarios.

La serie Memory reinterpreta la elegancia de la piedra dando vida a espacios con una fuerte expresividad.

La riqueza de los detalles de la superficie crea un efecto piedra muy realístico creando entornos con un gran valor estético.

Con una gama de colores naturales y suaves, es ideal para crear continuidad a los espacios convirtiendo la colección apta para cualquier escenario elegante y refinado.



Memory Marfil 160x160 / 63"x63"

# MEMORY

PORCELAIN · PORCELÁNICO

PERLA



## AVAILABLE COLOURS · COLORES DISPONIBLES



BLANCO



PERLA

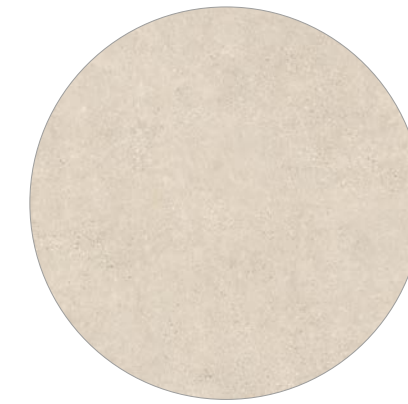

MARFIL

## FORMATOS DISPONIBLES · AVAILABLE SIZES



48"x110"  
120x280

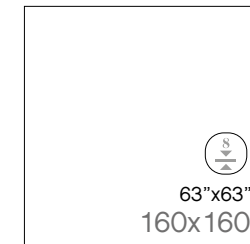

63"x63"  
160x160

## CARACTERÍSTICAS TÉCNICAS · TECHNICAL CHARACTERISTICS



Wall Tiles  
Revestimiento



Floor Tiles  
Pavimento



Matt  
Mate



High shade variation  
Destonificado



Thickness  
Espesor



Thickness  
Espesor

## PACKING LIST

Size Medida	Pcs/Pallet Pz/Palet	Sqm/Box m <sup>2</sup> /Caja	Sqm/Pallet m <sup>2</sup> /Palet	Kg/Pallet Kg/Palet
120x280	20	3,36	67,20	1.062,00
160x160	20	2,56	51,20	1.066,00

	120x280	160x160
● Mate	M171	M205

# CARNABY

PORCELAIN · PORCELÁNICO

geoSLAB

A cement finish that transforms the place in pure and neutral spaces. It stands out for its consistency and sobriety, reinforcing the decorative elements of the rooms. Cement is reinvented to become the centre of the decoration and the great protagonist of the space.

Un acabado cemento que convierte los espacios en sitios puros y neutros. Destaca por su consistencia y sobriedad reforzando los elementos decorativos de las estancias.

El cemento se reinventa para convertirse en el centro de la decoración y gran protagonista del espacio.



Carnaby Blanco 120x280 / 48"x110"

# CARNABY

PORCELAIN · PORCELÁNICO

GRIS



## AVAILABLE COLOURS · COLORES DISPONIBLES



BLANCO



GRIS

## FORMATOS DISPONIBLES · AVAILABLE SIZES



48"x110"  
120x280

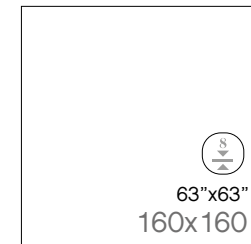

63"x63"  
160x160

## CARACTERÍSTICAS TÉCNICAS · TECHNICAL CHARACTERISTICS



Wall Tiles  
Revestimiento



Floor Tiles  
Pavimento



Matt  
Mate



High shade variation  
Destonificado



Thickness  
Espesor



Thickness  
Espesor

## PACKING LIST

Size Medida	Pcs/Pallet Pz/Palet	Sqm/Box m <sup>2</sup> /Caja	Sqm/Pallet m <sup>2</sup> /Palet	Kg/Pallet Kg/Palet
120x280	20	3,36	67,20	1.062,00
160x160	20	2,56	51,20	1.066,00

	120x280	160x160
● Mate	M171	M205

# GROUND

PORCELAIN · PORCELÁNICO

geoSLAB

Series emulating the cement with the texture of an essential material and with a strong visual impact.

A pure and minimalist aesthetic with great effect, perfect for those who wish to recreate simple spaces full of personality.

Serie imitación cemento con la textura de un material esencial y con un fuerte impacto visual.

Una estética pura y minimalista de gran efecto, perfecta para los que desean recrear espacios sencillos y cargados de personalidad.



Ground Perla 120x280 / 48"x110"

# GROUND

PORCELAIN · PORCELÁNICO

ARENA



## AVAILABLE COLOURS · COLORES DISPONIBLES



PERLA



GRIS

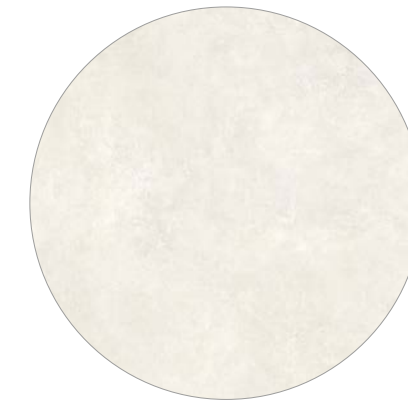

ARENA

## FORMATOS DISPONIBLES · AVAILABLE SIZES



## CARACTERÍSTICAS TÉCNICAS · TECHNICAL CHARACTERISTICS



Wall Tiles  
Revestimiento



Floor Tiles  
Pavimento



Matt  
Mate



High shade variation  
Destonificado



Thickness  
Espesor

## PACKING LIST

Size Medida	Pcs/Pallet Pz/Palet	Sqm/Box m <sup>2</sup> /Caja	Sqm/Pallet m <sup>2</sup> /Palet	Kg/Pallet Kg/Palet
120x280	20	3,36	67,20	1.062,00

	120x280
● Mate	M171

# PORTLAND

PORCELAIN · PORCELÁNICO

geoSLAB

The Portland collection, with its neutral and urban appearance, filled with contemporary nuances, stands out for its marked timeless and functional character. Through its consistency and sobriety, Portland enhances decorative elements, adding a modern and sophisticated touch to any space. Presented in a wide variety of formats and 4 colours, with their corresponding decorative tile, this collection is characterized by its great versatility and aesthetic improvements, adding value to spaces.

La serie Portland, de apariencia neutra, urbana, llena de matices contemporáneos, destaca por su marcado carácter atemporal y funcional.

Por su consistencia y sobriedad, refuerza los elementos decorativos aportando un toque moderno y sofisticado a cualquier espacio.

Presentada en gran variedad de formatos y 4 colores, con sus respectivos decorados, esta serie se caracteriza por su gran versatilidad y mejoras estéticas, agregando valor a una estancia.



Portland Marfil 120x280 / 48"x110"



# PORTLAND

PORCELAIN · PORCELÁNICO

BLANCO



## AVAILABLE COLOURS · COLORES DISPONIBLES

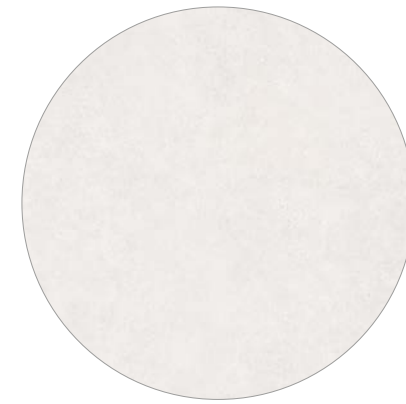

BLANCO

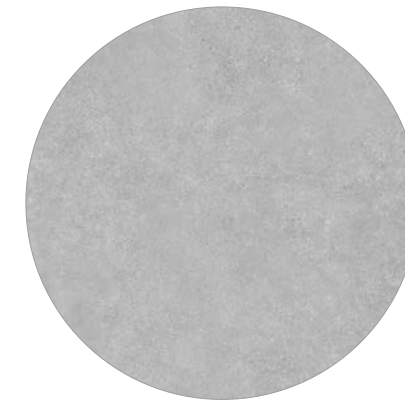

PERLA

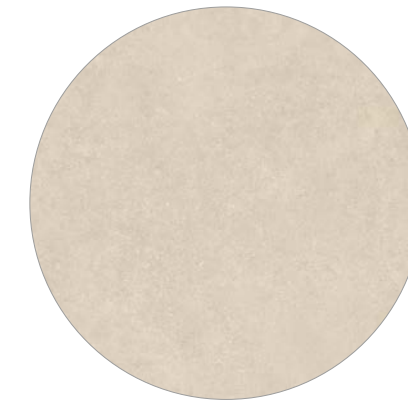

MARFIL

## FORMATOS DISPONIBLES · AVAILABLE SIZES

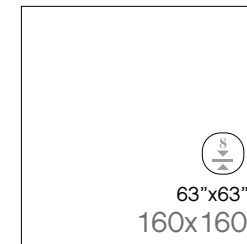

## CARACTERÍSTICAS TÉCNICAS · TECHNICAL CHARACTERISTICS



Wall Tiles  
Revestimiento



Floor Tiles  
Pavimento



Matt  
Mate



High shade variation  
Destonificado



Thickness  
Espesor



Thickness  
Espesor

## PACKING LIST

Size Medida	Pcs/Pallet Pz/Palet	Sqm/Box m <sup>2</sup> /Caja	Sqm/Pallet m <sup>2</sup> /Palet	Kg/Pallet Kg/Palet
120x280	20	3,36	67,20	1.062,00
160x160	20	2,56	51,20	1.066,00

	120x280	160x160
● Mate	M171	M205

# BLANCO

PORCELAIN · PORCELÁNICO

geoSLAB

An elegant white color that stands out for its timelessness and luminosity. Its contemporary design fuses the purity of white with the amplitude of the large format, providing a soft and uniform glow. Ideal for spaces, it reflects light, providing spaciousness and freshness. In addition to its dazzling aesthetics, it guarantees durability and stain resistance.

Un elegante color blanco que destaca por su atemporalidad y luminosidad. Su diseño contemporáneo fusiona la pureza del blanco con la amplitud del gran formato, proporcionando un resplandor suave y uniforme. Ideal para espacios, refleja luz, aportando amplitud y frescura. Además de su estética deslumbrante, garantiza durabilidad y resistencia a las manchas.



Blanco 120x280 / 48"x110"  
Memory Perla 160x160 / 63"x63"

# BLANCO

PORCELAIN · PORCELÁNICO

BLANCO

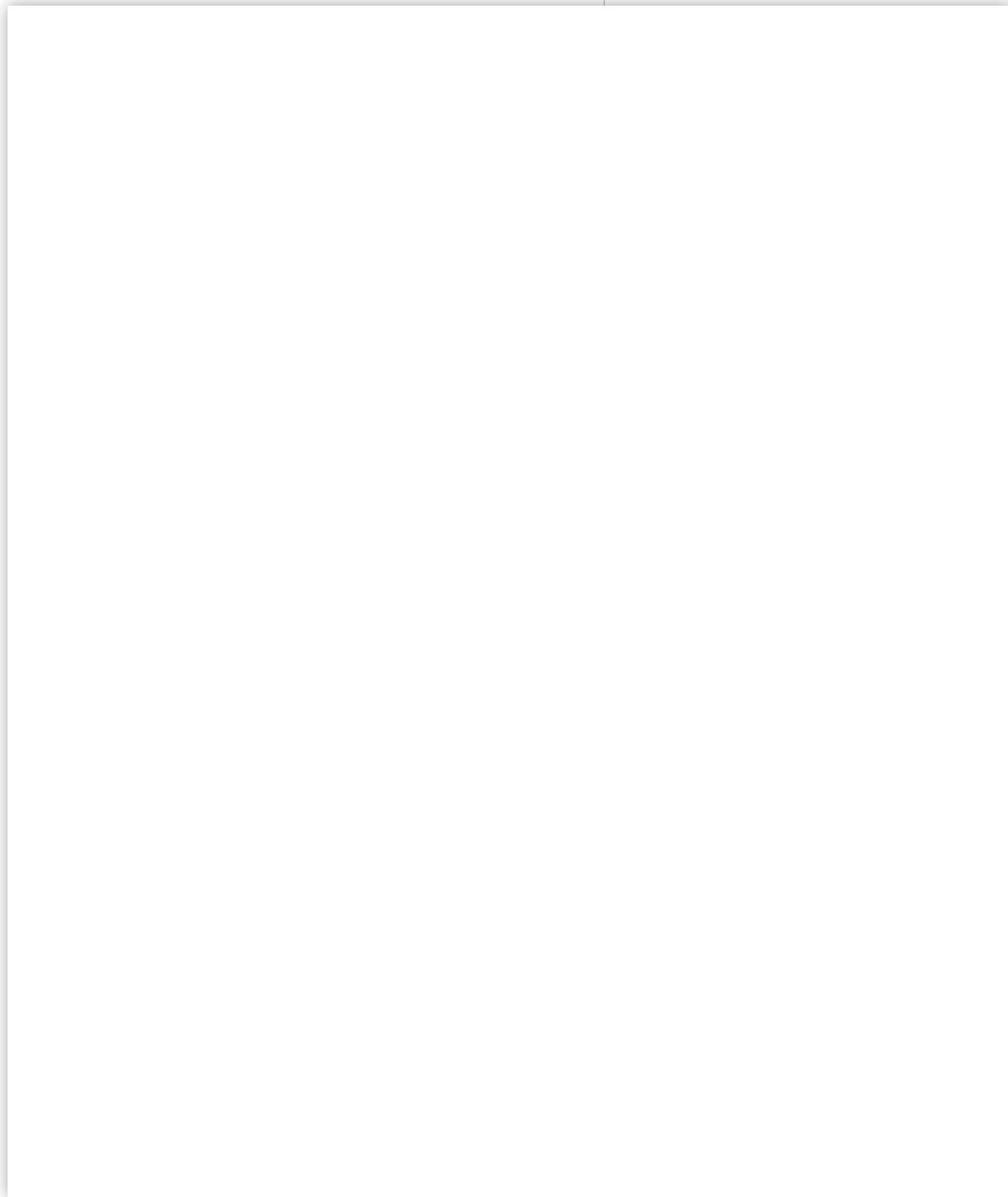

## AVAILABLE COLOURS · COLORES DISPONIBLES

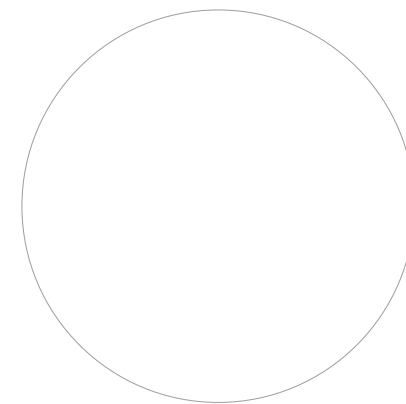

BLANCO

## FORMATOS DISPONIBLES · AVAILABLE SIZES



## CARACTERÍSTICAS TÉCNICAS · TECHNICAL CHARACTERISTICS



Wall Tiles  
Revestimiento



Floor Tiles  
Pavimento



High Polished  
Alto Pulido



Satin matt  
Satinado mate



High shade variation  
Destonificado



Thickness  
Espesor

## PACKING LIST

Size Medida	Pcs/Pallet Pz/Palet	Sqm/Box m <sup>2</sup> /Caja	Sqm/Pallet m <sup>2</sup> /Palet	Kg/Pallet Kg/Palet
120x280	20	3,36	67,20	1.062,00

	120x280
Satinado	M171
Pulido	M172

DISPLAY  
EXPOSITOR

geoS<sub>LAB</sub>

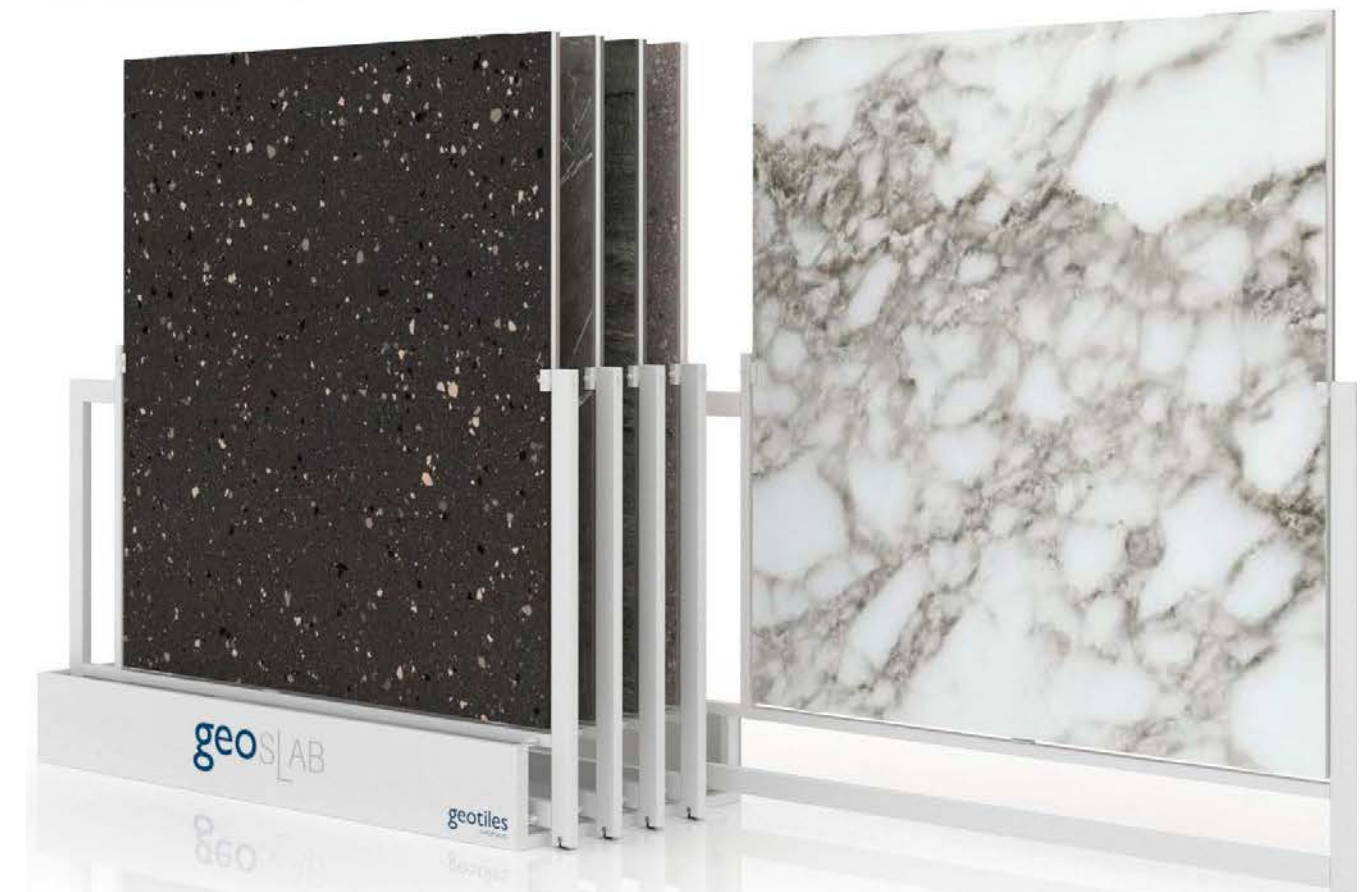
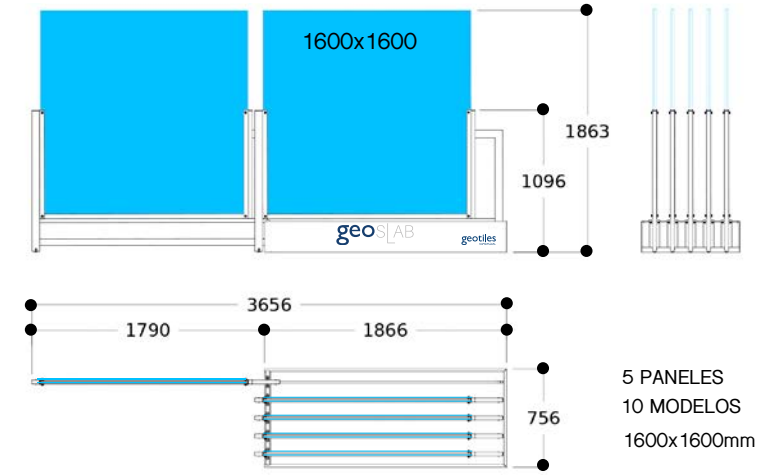

Due to technical reasons, dimensions and finishes may vary slightly.  
Dimensiones y acabados pueden sufrir pequeñas variaciones por cuestiones técnicas.

DISPLAY EXPOSITOR

BOX CAJA

FITTING RECOMMENDATIONS RECOMENDACIONES DE INSTALACIÓN

DISPLAY  
EXPOSITOR

geoSLAB

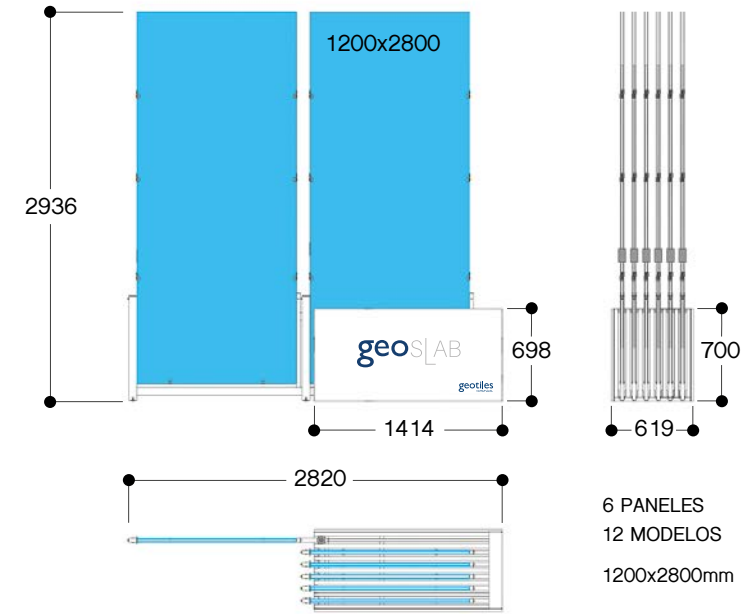

Due to technical reasons, dimensions and finishes may vary slightly.  
Dimensiones y acabados pueden sufrir pequeñas variaciones por cuestiones técnicas.

BOX  
CAJA

geoSLAB



DISPLAY  
DISPLAY



PIECES  
PIEZAS

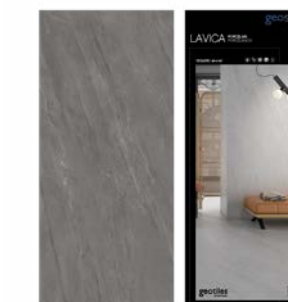

Due to technical reasons, dimensions and finishes may vary slightly.  
Dimensiones y acabados pueden sufrir pequeñas variaciones por cuestiones técnicas.

# 1 HANDLING AND TRANSPORT OF THE SLAB

For a proper handling of the boxes, a fork-lift or a hand truck must be used. It's recommended to handle the box by the wide part itself and with, at least, 1,20m long forks, never using the central space to load.

It can be handled as well by the narrow side of the box. The use of the forks must be of, at least, 2,20m long, bringing them to the maximum length possible to cover the maximum surface area of the box.

For the loading and unloading, hits and abrupt movements must be avoided. They can damage the slab very negatively.

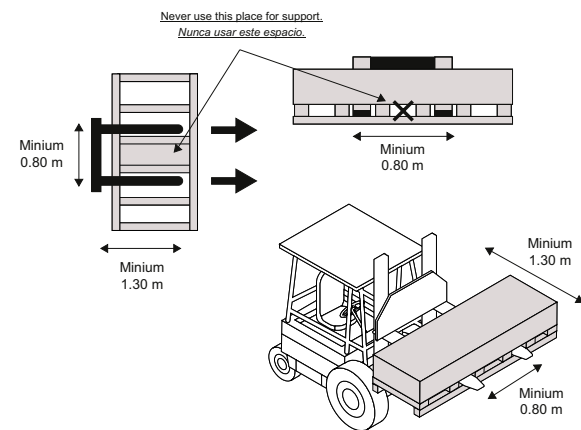

# MANIPULACIÓN Y TRANSPORTE DE LA PLACA

Para una correcta manipulación de los cajones, se utilizará una carretilla elevadora o transpaleta manual. Se recomienda manipular el cajón por la parte ancha del mismo con las palas de al menos 1,20m de longitud. Nunca se debe utilizar el hueco central para cargar.

También se puede manipular por la parte estrecha del cajón, usando palas de al menos, 2,20m de longitud, alargándolas al máximo para abarcar la mayor superficie posible del cajón.

Para su carga y descarga se deben evitar los golpes y movimientos bruscos que puedan afectar negativamente a la placa.

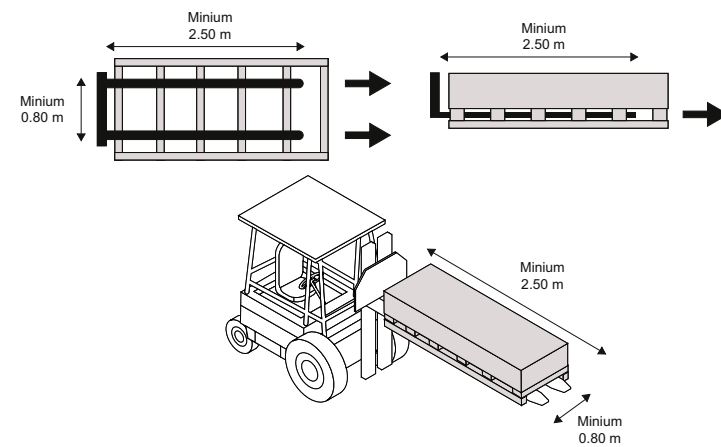

# 2 HANDLING OF THE SLAB

The handling of the slabs must be conducted with special care, due to its size and thickness. It's advised to handle the slab by several workers, either manually or using soft sucker rubbers that guarantee the adherence to the piece to hold the slab through all the directions.

It's recommended to remove the slab from the box by 2 workers, lifting it carefully through the large side of the piece, being both coordinated to move it. It's important to maintain the slab always in a rectilinear position and hold it by the upper part. You will never handle the slab in a horizontal position, this might cause a severe bending.

In case to support the slab on the ground and the wall in horizontal position, it's recommended to use protectors at any time. If you put the slab on a worktable, make sure that the surface is completely flat.

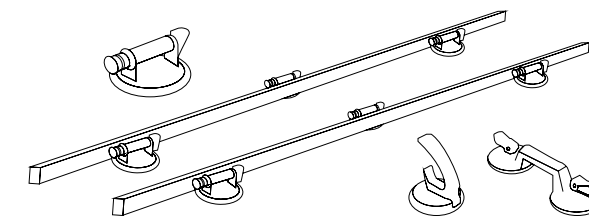

# MANIPULACIÓN DE LA PLACA

La manipulación de las placas se debe realizar con especial cuidado, por su tamaño y espesor. Se aconseja manipular la placa entre varios operarios, puede ser manualmente o bien utilizando ventosas que dispongan de goma blanda que garanticen la adherencia a la pieza y sujeten la placa en todas las direcciones.

Se recomienda extraer la placa del cajón entre 2 operarios, levantando ligeramente por la parte más ancha de la misma. Sujetar la placa con ambas manos, levantarla con cuidado y al mismo tiempo que el compañero, desplazarla hasta su lugar. Es importante que mantenga siempre la placa en posición rectilínea y sostenida por la parte superior. Nunca transporte la placa en posición horizontal, ya que esto provocará un pandeo excesivo de la misma.

En caso de apoyar la placa sobre el suelo y la pared en posición horizontal se recomienda siempre utilizar protectores. Si va apoyar la placa sobre la mesa de trabajo, asegúrese de que la superficie este completamente plana.

## 3 CUTTING, DRILLING AND FINISH

The voluminous dimensions of the slabs and its slim thickness do not limit the cutting, drilling and finishes operation on the edges with easiness and without the need to recur to machinery or equipment of big dimensions at high costs. These operations can be conducted and the job site with the proper equipment.

The conduction of the cuts can be done either in dry or wet systems. The methods are:

### 3.1 CUTTING USING TOOLS FOR GLASS:

Cutting through tools for glass (from small manual glasscutters to industrial cutting equipment), have the advantage of high accuracy, speed, and easy cleaning.

## CORTE, PERFORACIÓN Y ACABADO

Las grandes dimensiones de las placas y su menor espesor no impiden operaciones de corte, perforación y acabados de cantos con relativa facilidad y sin recurrir a equipamiento o maquinaria de grandes dimensiones ni costes elevados. Estas operaciones se pueden realizar en la misma obra con el equipamiento adecuado.

La ejecución de los cortes se puede utilizar tanto en sistemas en seco como húmedos. Los métodos que se pueden utilizar son:

### 3.1 CORTE HERRAMIENTAS PARA VIDRIO:

El corte mediante herramientas para vidrio (desde pequeños cortavidrios manuales hasta equipos de corte industrial), cuentan con la ventaja de un corte de gran precisión, velocidad y fácil limpieza.

### 3.2 CUTTING USING SPECIFIC TOOLS:

Dry cutting is the most common method for straight and diagonal cuts of all kinds. To make the cut, we must place the slab on the worktable, mark a line where we want to make the cut, place the specific cutting tool and set it in position to proceed with the manual cut.

Afterwards, we will proceed to split the slab with the help of pliers pressing in both ends. Finally, we will proceed to detach the remaining pieces with helping us with the edge of the worktable or by placing a block under the slab and applying the strength needed.

### 3.3 CUTTING WITH GUIDE AND RADIAL SAW:

There is also the possibility to proceed with dry cuts with discs or through a radial saw with water, either using hand tools or cutting worktables or similar. This system allows only to undertake straight cuts, however, having the advantage of being able to do it at the job site, however, for complex cuts, the process should be assisted with water jet cutters.

### 3.4 DRILLS AND HOLES:

To drill rounded holes, a screwdriver should be used as the slab is drilled by cutting, not by demolition.

It is recommended wet with water the part of the screwdriver to prevent tension on the slab and drill with low rotational revolutions.

### 3.2 CORTE HERRAMIENTAS ESPECIFICAS:

El corte en seco es el método más común para realizar cortes en seco rectos y diagonales de todo tipo. Para realizar el corte, debemos colocar la placa sobre la mesa de trabajo, marcaremos la línea de corte y procederemos al corte manual junto con la herramienta indicada.

Una vez realizado el corte, procederemos a la separación de la placa con ayuda de tenazas aplicando presión en ambos extremos. Finalmente, procedemos a la separación de las piezas restantes con ayuda del borde de la mesa o bien colocando un tope debajo de la placa y ejerciendo la fuerza necesaria hasta conseguirlo.

### 3.3 CORTE CON GUÍAS Y RADIAL:

También existe la posibilidad de realizar los cortes con disco en seco o mediante la radial con agua, bien con herramientas de mano o bancos de corte.

Este sistema permite realizar cortes únicamente rectos, pero tiene la ventaja de poder realizarse en la misma obra, sin embargo, para cortes más complejos es necesario recurrir al corte con chorro de agua.

### 3.4 TALADROS Y AGUJEROS:

Para realizar agujeros redondos se deben usar taladros no percutores ya que la placa se perfora por corte, no por demolición.

Se recomienda refrigerar con agua el punto de inicio del taladro para evitar tensiones en la placa y empezar a taladrar con bajas revoluciones de giro.

## 4 SLAB PLACEMENT PROCESS

The surface where the slab is going to be installed must be in good conditions in order to achieve a high-ending result. The installation process must be done as follows:

### 4.1 GLUE APPLICATION TO THE SURFACE:

The glue must be applied on the colocation surface where afterwards we will spread it out with the flat area of the trowel and then we will proceed to use the toothed side in straight and perpendicular direction.

It's important to do this process in the least possible time to make sure that the glue will not affect the adherence of the slab.

### 4.2 DOUBLE GLUING:

It's compulsory to apply a double glue application on the back and on the surface of the slab.

The application must not exceed the advised glue thickness recommended by the manufacturer.

## PROCESO DE COLOCACIÓN DE PLACA

Es importante que el soporte sobre el que se va a instalar la placa esté en buenas condiciones para un acabado de calidad. Se debe realizar el proceso de instalación de la placa siguiendo estas indicaciones:

### 4.1 APLICACIÓN DEL ADHESIVO AL SOPORTE:

En primer lugar, se aplica el adhesivo sobre la superficie de colocación y se extiende con la parte lisa de la llana y posteriormente se somete a la operación de "peinado" en línea recta y perpendicular. Es importante realizar esta operación en el menor tiempo posible para evitar que el adhesivo no afecte a la adherencia de la pieza.

### 4.2 DOBLE ENCOLADO:

En segundo lugar, es obligatorio la aplicación del adhesivo mediante la técnica del doble encolado, es decir, aplicar el adhesivo tanto en el reverso de la placa como sobre el soporte. La aplicación del doble encolado no debe superar el espesor recomendado para la capa adhesiva recomendada por el fabricante.

### 4.3 SLAB PLACEMENT:

It is important to keep a coordinated work in all the installing team to carry the slab to the closest area where the slab will be installed, therefore, we will minimize any possibility to correct or readjust the piece.

Once the slab is placed with its fresh glue, we will hit it with a rubber hammer to remove all the air that might have been kept during the process.

### 4.4 SISTEMA DE NIVELACIÓN:

A levelling system is needed where big formats are used. This system will help to achieve a completely flat and uniform finish. The system is undertaken through pressure to the slabs and its adjoining pieces meanwhile the glue is setting. However, we will need to take precautions to avoid that any strength can damage to the adherence itself.

### 4.5 JOINING PROCESS:

The placement joints must be completely dried, clean of residues and fully empty before its sealing. The application of the joining will be taken by the manufacturer's instructions.

The joint will be spread using a flat rubber trowel filling all the spaces with diagonal movements, afterwards, we will wait the recommended time by the manufacturer prior to the cleaning process. Once we reach that time, we will clean all the placement joining left with a wet sponge through diagonal movements to the joints.

### 4.6 FINAL CLEANING:

A proper cleaning conduction after the installation it is a must to do in order to remove all the residues and general waste. It is advised to use a light acid cleaning detergent without toxic gases. In case we will use a epoxy joint or in a resin surface, it's recommended to do the final cleaning with an specific epoxy joint cleaner.

### 4.3 COLOCACIÓN DE LA PLACA:

Importante el trabajo de coordinación del equipo de instaladores para colocar la placa lo mas aproximadamente posible a su ubicación definitiva. De este modo se minimiza la posibilidad de tener que corregir o reajustar la pieza.

Con la placa colocada y el adhesivo fresco, se realiza la operación de golpe con una maza de goma para extraer todo el aire que haya quedado encapsulado entre las placas adheridas durante la colocación.

### 4.4 SISTEMA DE NIVELACIÓN:

Es necesario el uso de un sistema de nivelación para formatos grandes para ayudar a conseguir acabados completamente planos y uniformes.

El sistema nivelación se aplica ejerciendo presión sobre las placas contiguas durante el proceso de instalación mientras el adhesivo esté fraguando, por ello tenemos que tomar ciertas precauciones para evitar que la fuerza ejercida pueda afectar negativamente a la adherencia.

Una vez completamente fraguado el adhesivo quitar los soportes, haciendo separar la parte sobresaliente de la base mediante un ligero golpe transversal.

### 4.5 PROCESO DE REJUNTADO:

Las juntas de colocación deben estar secas, limpias. La aplicación del material de rejuntado se realizará según las instrucciones del fabricante. Se debe extender la pasta de rejuntado utilizando una llana de goma adecuada rellenando las juntas en toda su profundidad con movimientos diagonales, esperar el tiempo indicado por el fabricante para iniciar a la limpieza que debe ser retirado con una esponja humedecida en diagonal a las juntas.

### 4.6 LIMPIEZA FINAL DE OBRA:

Es muy importante después de la colocación realizar una buena limpieza con el fin de eliminar todos los residuos de junta y en general de suciedad de la obra. Para esto recomendamos un detergente de acción ligeramente ácida que no despiden humos tóxicos y respete las juntas. En el caso de material de colocación con junta epoxi o en base de resina, se aconseja realizar la limpieza final de obra con un limpiador específico de residuos epoxi.



[www.geotiles.com](http://www.geotiles.com)

Geotiles S.L.U operates a policy of continuous development and reserves the right to make changes to its products, colours, engineering specifications, packaging codes without prior notice. Geotiles has taken every effort to ensure that the information contained in the catalogue is correct at the time of publication. Due to the limitations of the printing process, the colours reproduced may vary slightly from the original product.

Geotiles S.L.U aplica una política de continuo desarrollo de sus productos y se reserva el derecho a realizar cambios en los productos,colores, especificaciones técnicas y códigos sin previo aviso. Geotiles ha realizado un esfuerzo considerable para que toda la información sea adecuada en el momento de la publicación del catálogo. A causa de las limitaciones del proceso de impresión los colores reproducidos pueden sufrir ligeras variaciones con respecto al producto original.